



# AlluGuard

style, security, innovation...

Welcome to your  
guide to the very  
best insulated  
roller garage doors

New! Custom  
coloured  
doors!



Secured by Design



Police Preferred Specification



the  
GARAGE  
DOOR  
CHANNEL

Watch AlluGuard online at: [www.thegaragedoorchannel.co.uk](http://www.thegaragedoorchannel.co.uk)

What's important  
when it comes to  
choosing a new  
door?



Read on... or watch online at:  
[www.thegaragedoorchannel.co.uk](http://www.thegaragedoorchannel.co.uk)



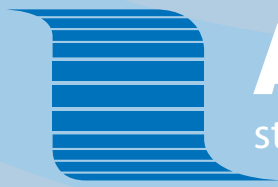

# AlluGuard

style, security, innovation...

<b>Security</b>	page 8
<b>Insulation</b>	page 10
<b>Convenience</b>	page 13
<b>Colours</b>	page 14
<b>Remote Control</b>	page 21
<b>AlluGuard 77 Features</b>	page 22
<b>AlluGuard 55 Features</b>	page 24
<b>Accessories</b>	page 26
<b>Smart Home</b>	page 27



## Trusted and quality assured

AlluGuard is totally focussed on you. Choosing a product for your home as important as a garage door is not something you do very often. Perhaps only once or twice in a lifetime!

To purchase with confidence requires a company you can trust - a quality assured company.

AlluGuard's reputation is built on quality and we are independently certified to prove that our quality management systems are industry acknowledged! Our products are designed to give you the ultimate in performance ensuring that you'll be happy to recommend AlluGuard.

Safety always comes first at AlluGuard. All our products carry a CE mark and have been independently tested for safe operation and compliance with legislation to EN 13241-1.



**Buy with confidence!**



# Insulated Roller Garage Doors



 AlluGuard 77 AlluGuard 55

No other door  
is quite like an  
AlluGuard door!

# Insulated Roller Garage Doors

Insulated roller garage doors are wonderfully simple in everyday use thanks to smart technology. Over the coming pages, we'll introduce the clever features on AlluGuard insulated roller garage doors, but by way of introduction, here are the highlights:

How easy is that!

## They open at the touch of a button

Smart controls ensure safe and effortless opening every time.



## They are Police Approved

for security. Protect valuable items stored in your garage with our independently tested Secured by Design door, the AlluGuard77.



## They take up less space

than any other garage door, rolling up into a compact space with no tracks projecting into the garage.



## They make extra space

by fitting behind the opening, giving you a wider and taller opening. This increases drive-through width by up to 150mm (6") and drive-through height by up to 75mm (3"). Vertical opening means the door doesn't project out onto your drive or into the garage space, allowing you to park up to the door inside and out.



## They keep out the weather

so your garage is no longer a draughty no-go area.



Read on... or watch online at:  
[www.thegaragedoorchannel.co.uk](http://www.thegaragedoorchannel.co.uk)



Everything works at just the touch of a button these days!



### They look simply stunning



The gentle curve and the subtle lines of each slat are finished in a tough polyester powder coating or a high grade laminate to create an overall look that is classic and contemporary in equal measure.

### They are covered by fair warranties



AlluGuard roller doors are covered by a comprehensive warranty of two and five years - see the back page for full details.



### They are quality assured & safe



Every door is manufactured to our ISO 9001 certified quality systems and CE certified and marked as safe to Directive EN 13241-1.

### AlluGuard 77 & AlluGuard 55 -

#### What's the difference?

Similar features only smaller! AlluGuard 55 uses a smaller slat than the AlluGuard 77 that allows it to roll tighter requiring less space at the top of the door. It's the ideal choice when headroom is especially limited.



**AlluGuard 77**

**AlluGuard 55**



# Security



## Security Matters

Bikes, fitness equipment, tools... Whatever you keep in your garage in addition to your car, it's always a surprise when you add up the value - often several thousand pounds! To keep your possessions secure, look for the Secured by Design symbol - the only form of national Police accreditation for security - you'll find it on our AlluGuard 77 garage door.

## Secured by Design

The AlluGuard77 is designed to be secure and has been awarded the Secured by Design Police Preferred Specification status. To achieve Secured by Design, doors are independently tested and certified to the standard, giving you peace of mind that your new garage door is secure to a Police approved standard. The AlluGuard55, whilst built for strength, is not available with Secured by Design status.

## Alarmed

The door control unit for AlluGuard 77 and 55 doors employs magnetic contacts on the bottom of the door to monitor the door's position when locked. If an attempt is made to lever the bottom of the door upwards, a piercing alarm is triggered to deter intruders.



The locking rings that hold the door curtain in the closed position and pulls the door curtain upwards, is a huge improvement over the conventional method other manufacturers use.

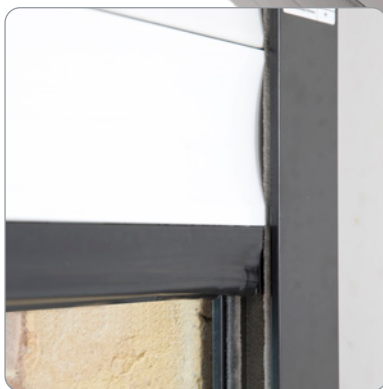

Heavy duty extruded aluminium guides secure the door at the sides.

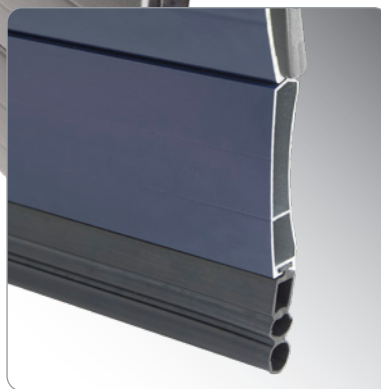

The extruded aluminium bottom slat adds extra strength to resist forcing. See page 15 for notes on colours.



Remote control means there's no external lock to pick or attack.



## What is Secured by Design?

Secured by Design (SBD) is the UK Police flagship initiative that is founded on the principles of designing out crime and crime prevention.

SBD supports one of the Government's key planning objectives: the creation of secure, quality places where people wish to live and work.

Research carried out by Huddersfield University shows that residents living on Secured by Design Developments are half as likely to be burgled and two and a half times less likely to suffer vehicle crime. Secured by Design Developments also benefit from 25% less criminal damage.

## Secured by Design



Police Preferred Specification

We store a lot of stuff in our garage, so the extra security of AlluGuard's roller door was first on the list for us !



U Value:  
5.2W/m<sup>2</sup>K

# Insulation



Fully Insulated & Finished to Perfection

AlluGuard is designed to give thermal and acoustic insulating properties much higher than the average garage door.

'CFC' Free Polyurethane Foam within the Aluminium Lath plus high performance weather sealing ensures good insulation.

It's perfect if you want to use your garage as a work/play room or your garage is under a bedroom.

The corrosion resistant aluminium laths are light yet strong and can be finished in a range of solid colours or woodgrain textures - see pages 14-19.

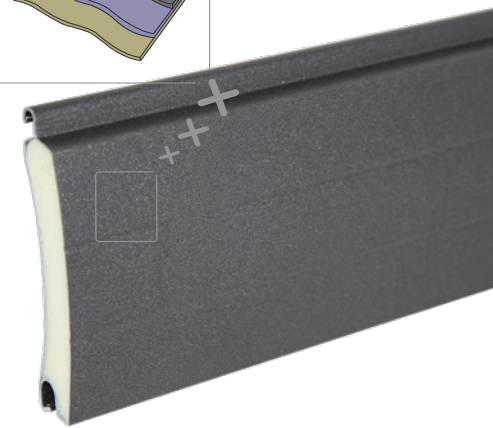

Brush strips reduce draughts and the bottom seal keeps out wind blown debris.

Bedrooms over your garage? Help keep the chills out with insulated lath and advanced weather sealing.



Keeping my home warm is top on my list of priorities!



Home gym? Why not!



Being able to park right up is a huge benefit to me!



Doors can be fitted externally if headroom is very limited inside the garage. The roll box will be visible and the concave face of the door slats faces outwards. Please note the finish warranty of the exposed face on doors fitted this way is 2 years.

# Convenience

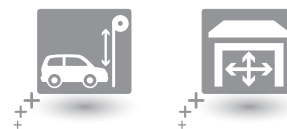

## No wasted space

Roller garage doors operate vertically, rolling into a compact coil within the garage, above the opening. Not only does this mean you can park right up to the garage door, but valuable space is not taken up inside your garage which could be used for storage.

## Takes up less space

Because it rolls 'tighter' than other roller doors, AlluGuard takes up less headroom when open - just 300mm for the AlluGuard 77 and even less for AlluGuard55 at 205mm.

The door typically sits behind the brickwork, allowing any existing frame to be removed. This increases drive-through width by up to 150mm (6") and drive-through height by up to 75mm (3").

This, and its very compact side runners, gives you much more room to manoeuvre.

Doors can even be fitted externally where headroom is extremely limited.

## Good looks inside and out

The outside of the door is simply stunning, the inside equally impressive. Whether you choose a powdercoated door with matching guides and box or a laminated door with White, Mocca Brown or Black guides and box, the installation is incredibly neat and compact - no wasted space!



The neat inside is made even tidier with the option of a box to house the door roll.



Extra drive through width of up to six inches - 150mm helps keep your wing mirrors unmarked!



## Standard Colour Range

### Solid powdercoat colours

Low maintenance powdercoat finishes for AlluGuard77 garage doors are available in these stylish colours:

\* Denotes non-stock colour options

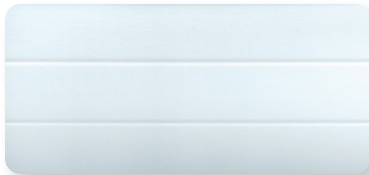

White RAL 9016

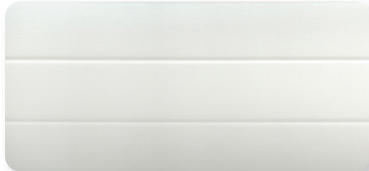

Cream RAL 9001



Home Cream RAL 1015

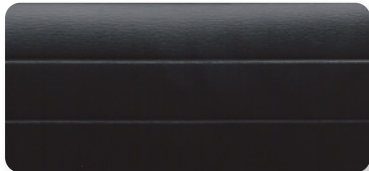

Black RAL 9011

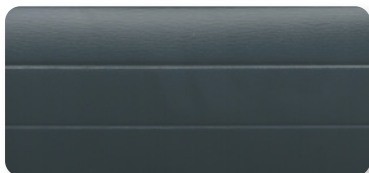

Anthracite Grey RAL 7016



\*Silver RAL 9006



Graphite Metallic



\*Pale Grey RAL 7038

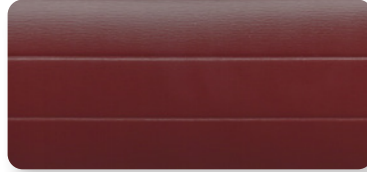

Burgundy RAL 3004

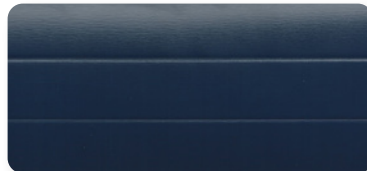

Blue RAL 5011



Duck Egg Blue BS 18 E 50



Chartwell Green BS 14 C 35



Racing Green RAL 6009



\*Moss Green RAL 6005

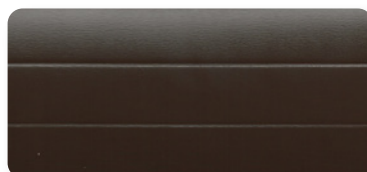

Mocca Brown RAL 8019

### Solid laminate colours

Low maintenance solid colour laminate finishes for AlluGuard77 door are available in the following colours:

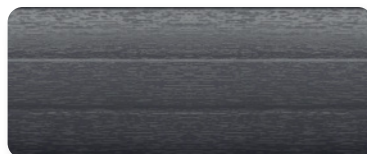

Slate Grey RAL 7015

### Wood effect powdercoat

Low maintenance wood effect powdercoat finishes for AlluGuard77 door are available in the following wood shades:

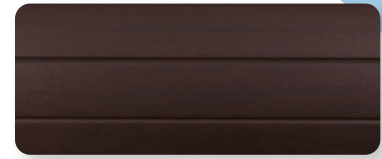

Rosewood Painted

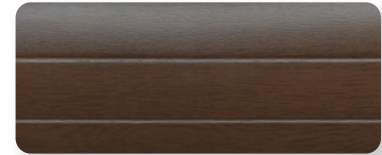

\*Walnut Painted



Golden Oak Painted



\*Irish Oak Painted

### Wood effect laminate

Low maintenance wood effect laminate finishes for AlluGuard77 door are available in the following wood shades:

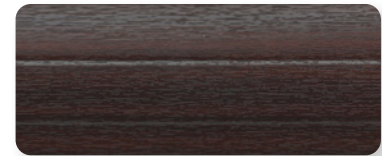

Mahogany



Golden Oak

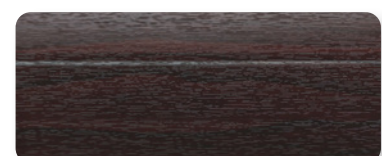

Rosewood

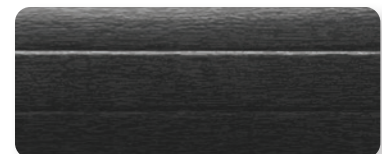

Black

## Notes on colours

Coloured guide rails are supplied as standard, however, they may not perfectly match the lath colour. The manufacturing process for the lath profile results in a textured finish, whilst all other coloured items (guides, bottom laths, lock laths, optional fascias and vision panels) are supplied in a satin finish, so cannot be guaranteed to match exactly. Over time some scuffing / pressure marks may occur on front and rear surfaces of doors as a result of their normal operation.

Colours shown are for guide purposes only and are limited by the printing process. Please ask to see a colour sample to confirm your choice.

# AlluGuard 77

I want my garage door to match my windows!

## Colours

AlluGuard's wide choice of finishes ensure your new garage door not only looks good for years to come, but also complement the look of your home. Don't see the colour you want? Explore our extended range of laminate finishes and custom colours on pages 18-19.



### The door curtain

The door curtain is available in the solid powdercoat and laminate colours and wood effect powdercoat and wood effect laminate colours shown left.

The rear of the door slats is finished to match the front on solid colour powdercoated and wood effect powdercoated doors. Wood effect laminates and solid colour laminates have a White or Mocca Brown rear. White is standard for solid colours, Mocca Brown for wood effects.



The standard configuration is with no roll box.



### The door guides

The guides colour match\* the door curtain colour as standard on all solid powdercoat colours. Wood effect powdercoat and laminate doors are supplied with White, Mocca Brown or Black guides.

Rosewood and Golden Oak powdercoat wood effects are also available with a complementing powdercoat finish as an optional extra.

\*See notes on colour at the top of the page



The half box option helps prevent debris dropping onto the door roll



### The door roll box

Doors are supplied without a roll box as standard but are available as an option with a half or full roll box. These are finished to match the door guides for all solid powdercoat colours\*\*. Wood effect powdercoat/laminates and solid laminate colours are finished in White, Mocca Brown or Black\*\*.

\*\*Rosewood and Golden Oak powdercoat wood effects and Graphite Metallic are also available finished with a complementing powdercoat wood effect/Metallic finish as an optional extra.



The full box option encloses the door roll for a very neat installation.



Requiring only 205mm of headroom, the AlluGuard55 has the benefits of the larger AlluGuard77, but in a very compact space.

## Standard Colour Range

### Solid powdercoat colours

Low maintenance powdercoat finish for AlluGuard55 garage doors are available in these classic colours:

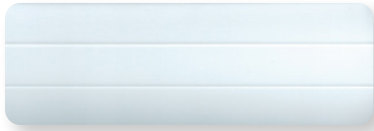

White RAL 9016

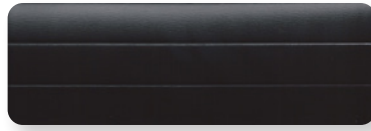

Black RAL 9005

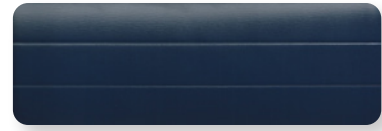

Blue RAL 5011

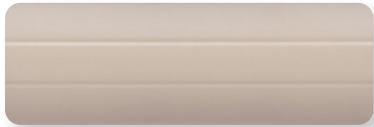

Light Beige BS 08B17

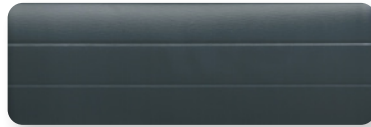

Anthracite Grey RAL 7016

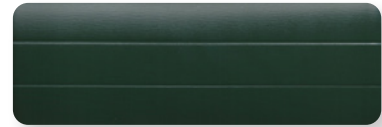

Racing Green RAL 6009



Home Cream RAL 1015

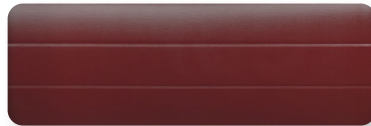

Burgundy RAL 3004



Brown RAL 8014

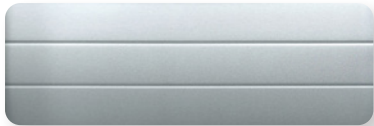

Silver Metallic RAL 9006



Pale Grey RAL 7038



Chartwell Green BS 14 C 35

### Wood-effect powdercoat

Low maintenance powdercoat wood effect finish for AlluGuard55 garage doors are available in these classic colours:



Mahogany

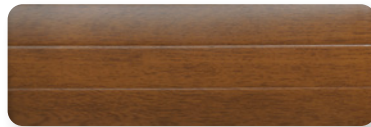

Golden Oak

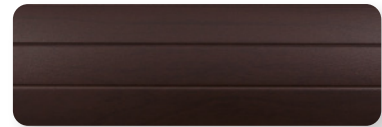

Rosewood



The AlluGuard 55 fits in smaller spaces!



## Notes on colours

Coloured guide rails are supplied as standard, however, they may not perfectly match the lath colour. The manufacturing process for the lath profile results in a textured finish, whilst all other coloured items (guides, bottom laths, lock laths, optional fascias and vision panels) are supplied in a satin finish, so cannot be guaranteed to match exactly. Over time some scuffing / pressure marks may occur on front and rear surfaces of doors as a result of their normal operation.

Colours shown are for guide purposes only and are limited by the printing process. Please ask to see a colour sample to confirm your choice.

# AlluGuard 55

I'm smaller  
but perfectly  
formed!  
AlluGuard 55

## Colours

AlluGuard's wide choice of finishes ensure your new garage door not only looks good for years to come, but also complement the look of your home. Don't see the colour you want? Explore our extended range of laminate finishes and custom colours on pages 18-19.



### The door curtain

The door curtain is available powdercoat finished in the solid colours and wood effects shown left.

The rear of the door slats is finished to match the front.



### The door guides

The guides colour match\* the door curtain colour as standard on all solid powdercoat colours. Wood effect powdercoat doors are supplied with White, Brown or Black guides.

\*See notes on colour at the top of the page



### The door roll box

Doors are supplied with a half roll box as standard but are available as an option with a full roll box. These are finished to match the door guides for all solid colours. Rosewood, Golden Oak and Mahogany are finished in White, Brown or Black.

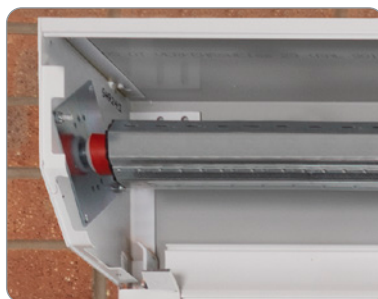

The half box is standard.



The full box option encloses the door roll for a very neat installation.

## Special Laminate finishes

In addition to our standard colour ranges, you can also order your door in special laminate finishes shown below. The laminate colours are selected from the Renolit Exofol high-performance films range for exterior applications. Renolit Exofol is the market leader, and its multi-layered structure protects and decorates many architectural surfaces such as windows and are ideal for garage doors. Finishes have a 10-year warranty against perforation of the substrate.

Doors with special laminates are available with the rear face of the door finished in White or Brown. White is standard for all solid colours, brown for wood effects. The guides and box are finished in White, Brown or Black.



Steel Blue RAL 5011



Moss Green RAL 6005

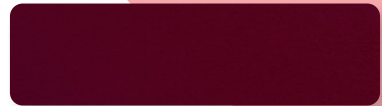

Wine Red RAL 3005



Brilliant Blue RAL 5007



Dark Green RAL 6009



Dark Red RAL 3011

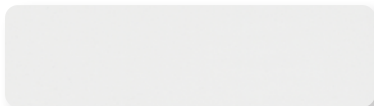

White RAL 9010

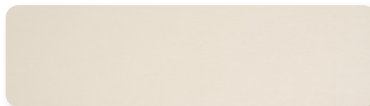

Cream White RAL 9001

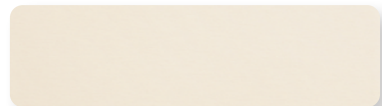

Ice Cream



Crystal White RAL 9003

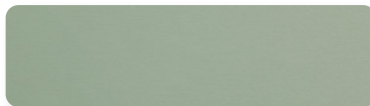

Chartwell Green BS 14 C 35

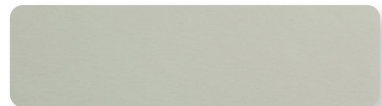

Agate Grey RAL 7038



Hazy Grey RAL 7001



Basalt Grey RAL 7012



Basalt Grey Smooth RAL 7012



Signal Grey Smooth RAL 7004

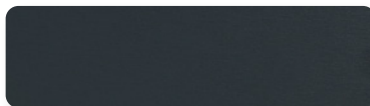

Anthracite Grey RAL 7015

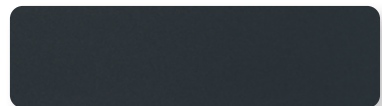

Anthracite Grey Smooth RAL 7015



Quartz Grey RAL 7039



Slate Grey RAL 7015



Slate Grey Finesse RAL 7015



Dark Oak



Light Oak



Sherwood



Irish Oak

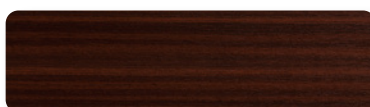

Mahogany



Walnut



Golden Oak



Black Cherry



Anteak

Want something special? Pick from the rainbow!

# Custom Colours

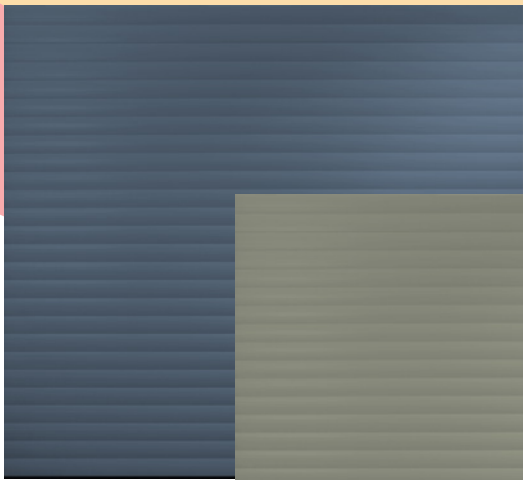

Matched to Farrow & Ball, Stiffkey Blue

Matched to Farrow & Ball, Treron



Matched to Dulux Trade Violet Verona 4



Matched to Little Greene Mister David



## Custom Colour finishes

In addition to our standard colours and special laminate ranges, you can also order your door in a custom colour.

Perhaps you have a RAL colour, a Farrow & Ball colour, a Little Greene shade or a Dulux Trade colour and you want your garage door be similar... No problem - our custom painting service is what you need!

We can custom paint your door to match. The wet-spray process uses paint mixed to match your chosen shade and gives a finish that is warranted for five years with suitable care and cleaning.

Custom coloured doors are available with guides and box finished in White, Brown or Black. As an option, the front face of the guides and the front face of the box are available painted to match the door curtain colour with the inner surfaces in White, Brown, or Black. The rear face of the door is available in White or Brown.

Fill your world with colour!



I want to open my door from the security of my car

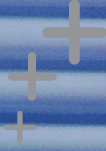

# Remote Control



## Effortless performance

Remote control is a standard feature that makes using your door effortless and secure. No need to get out of your car on a wet and windy night!

## Controls to suit you

With a range of controls available, choosing the ideal way to operate your doors couldn't be easier. Remote control, wall switch, keypad... see page 26 for the full range of options.

## The control unit

The Rollixo RTS wireless or wired control unit is the doors' "brain". It responds to signals from the remote control and other accessories to operate the door.

It has an integrated courtesy light to guide your way and buttons to operate the door. It also houses the intruder protection alarm that sounds when attempts are made to force the door by levering up the bottom slat.

HOME MOTION by  
**somfy**



## All AlluGuard garage doors come with the following:

- Rollixo RTS Wireless or Wired Control Unit
- 2 Keygo RTS Keyfobs
- Electrical Wireless Safety Edge / Optical Wired Safety Edge

## Remote control

Compact, stylish and keyfob friendly, the Somfy remote controls your doors and can also be programmed to control gates, lights and more in one stylish handset. Two are supplied as standard and more can easily be added.



## Safety Edge

Peace of mind protection for you and your family. The doors' bottom edge rubber seal incorporates an electric or optical sensor along its length to detect obstructions and instantly stop and reverse the door a short distance when closing.

Wireless and wired versions are available certified and marked as safe to Directive EN 13241-1.



# AlluGuard 77



Somfy Wireless and Wired  
(bottom sensor shown right)  
control units available



### 1 Power fail override

If the power fails, a simple hand crank is used to operate the door.



### 2 External power fail override

An optional external crank with lockable access is also available should there be no other access to the garage.



### 3 Keeps out the weather

Weather resistance is excellent with a rubber compression seal (not watertight) to the bottom of the door and a brush strip within the guides.

Secured by Design



Police Preferred Specification

**AlluGuard 77**

# Features at a glance

AlluGuard takes the concept of the roller garage door to a new level. It out-performs the ordinary garage door for ease of use, insulation, finishes, safety and security and all doors are manufactured

under strict and controlled guidelines. More and more homes are benefiting from an AlluGuard roller garage door - take a look at the features that make all the difference:



4

### Smooth & quiet

The barrel rings help reduce operating noise.



5

### Safe

The safety edge stops and reverses the travel of the door on contact with an obstruction.



6

### Powerful

Concealed within the barrel of the door is a powerful and quiet motor that drives the door and holds the curtain locked when closed.



7

### Secure

Security is excellent with strong locking straps that prevent forced lifting of the door.



8

### Complete control

The wall-mounted control unit has a courtesy light to guide your way and push button control for the door. The alarm is also housed in the control unit that sounds on an attempt to force up the door from the bottom slat.



9

### Safety brake

A safety brake is fitted to every AlluGuard 77 door that will prevent the door from dropping in the unlikely event of a motor failure. It includes a safety feature that automatically cuts power to the motor when the brake activates, protecting the door mechanism.

# AlluGuard 55



Somfy Wireless and Wired (bottom sensor shown right) control units available



### 1 Power fail override

If the power fails, a simple hand crank is used to operate the door.



### 2 External power fail override

An optional external crank with lockable access is also available should there be no other access to the garage.



### 3 Keeps out the weather

Weather resistance is excellent with a rubber compression seal (not watertight) to the bottom of the door and a brush strip within the guides.



I need just  
205mm of space  
above the  
opening to fit!

 AlluGuard 55

## Features at a glance

The AlluGuard 55 is small but perfectly formed. It doesn't cover the size range of the AlluGuard 77, being limited to single doors up to 3000mm wide

and 2225mm high, but only requires 205mm of headroom to install. Its compact size makes it the perfect solution when space is limited.



### Smooth & quiet

The lock straps create a smooth running surface to help reduce operating noise.



### Safe

The safety edge stops and reverses the travel of the door on contact with an obstruction.



### Powerful

Concealed within the barrel of the door is a powerful and quiet motor that drives the door and holds the curtain locked when closed.



### Secure

Security is excellent with strong locking straps that prevent forced lifting of the door.



### Complete control

The wall-mounted control unit has a courtesy light to guide your way and push button control for the door. The alarm is also housed in the control unit that sounds on an attempt to force up the door from the bottom slat.



### Fur lined

The front edge of the door box has a line of synthetic fur to increase weather protection and help reduce draughts.

# Automation Accessories

Automated as standard, the features of the AlluGuard77 and AlluGuard55 garage door systems are already at a luxury level. To further enhance day-to-day use, this range of control options provides extra flexibility.



## Secure Metal Keypad (IP54)

The anti-vandal keypad with a metal case and secure smart rolling code technology, gives you peace of mind for secure access to your garage.



## Smooove Wall Switch

The Smooove wall switch, available in white or black and single and double fittings, add touch sensitive controls to your new door system.



## Keygo Remote

Two Keygo 4 RTS remote controls are supplied with every door. Extra remote controls can be added and are easy to programme.



## Radio Wall Switch

This wall mounted wireless switch can be installed inside the garage or home for easy operation of your garage door. Also available wired.



## Wired Key Switch

This externally wall mounted key switch allows operation without the use of a hand transmitter and is an alternative to our keypads.



## Wireless Digital Keypad

This externally wall mounted keypad will accept a 4 to 13 digital code to open and close your garage door without the hand transmitter.



## Rocker Switch

This wall mounted wired rocker switch can be installed inside the garage or home for simple operation of your garage door.



## Standard Receiver RTS

The waterproof standard receiver allows keyfobs, keypads and key switches to effortlessly control 3rd party products including gates. Can be externally mounted.



## Lockable Override Cover

A lockable cover to protect the manual override access point on externally fitted doors.

# Accessories

## Door options



### Curtain roll box

Half and full boxes are available to suit AlluGuard77 doors. Either option will take up 300mm headroom on top of the guide height.

AlluGuard55 doors are supplied with half box as standard. Both half or full box has 205mm headroom on top of the guide height.

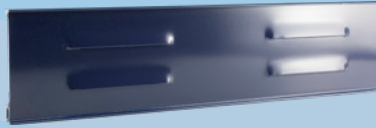

### Vented laths

Vented laths are available in powder coated colours only.



### Vision slats

Polycarbonate clear glazing is available for AlluGuard77 doors on a proportion of the door curtain to allow natural light into the garage (not available on AlluGuard55).

Woodgrain finish doors are only available with brown vision laths.



### Manual Exterior Release

For use in emergencies or in the event of power failure. The manual release allows the door to be opened manually from outside the garage - essential if the garage has no other entry point.

## Smart Living starts with AlluGuard

### Two systems:

CONNEXOON  
ACCESS



Connexoon, centres around access to and from your home, providing smart control of your garage door, gate and lighting.



“Smart Home” is no longer just a technology buzz word, but more and more part of every day life. It’s just so convenient to be able to control devices with your tablet, pc or smart phone.

At AlluGuard, we’ve embraced this exciting technology and called it “Smart Living”.

We’ve been using Somfy motors and controls on our garage doors for many years, so extending capability into smart technology with such a proven partner was an easy decision! Somfy’s Smart Home systems are the industries best!

TaHoma®



Tahoma is the complete smart home solution for monitoring and operating your garage doors, gates, blinds, curtains, lights, electrical equipment, heating and home security.

Take a look over the next two pages to see just how smart your home can be!

# CONNEXOON ACCESS



## An intuitive solution

The Connexoon Access RTS allows you to operate your Somfy motorised garage door, gate and lighting from your smartphone. Anytime, anywhere. Intuitive, smart, simple to use!

Connexoon Access RTS is simplicity itself to set up and the smart phone app is clear and simple to use, allowing control of up to 30 connected products.

## 4 smart functions

In addition to individual control of your connected products - open your garage door, turn on the drive lights, Connexoon Access RTS has four easy to configure smart functions:

### Welcome home...

Open and close all your access products with a simple click on your smartphone. The geolocation will make sure your garage door and gate will be open and lights on when you arrive to your home. You can adjust the distance from your house between 50 and 250m. The "Welcome home"-function is the true hands free access product, no more looking for controls, allowing full concentration when driving.

### Leave home...

Link the products you want to the "Leave home" function. The garage door can be closed and the lights on to imply occupancy while you are not at home.

## Compatible products



Rolling garagedoor  
Rollixo RTS



Gate openers RTS



Light RTS



Indoor plug RTS



Philips Hue lighting

## Open access...

Link the products you want to the "Open access" function. The garage door and gate can be opened and the lights on in one click!

## Close access...

All your access products can be closed with 1 click!



# TaHoma®

Somfy Smart Home puts you in control, makes your life easier, more comfortable and gives you peace of mind, wherever your are.

Monitor and operate your garage doors, blinds, curtains, lights, electrical equipment and heating with your smart-phone or tablet.

You can adjust everything about the Somfy Smart Home System to accommodate your personal preferences. Keep an eye on your home using cameras and movement detectors for home surveillance, great for peace of mind.

Somfy TaHoma is a smart box and the heart of your Smart Home. It links you to your home via the smart TaHoma app. Somfy Smart Home solutions are extremely easy to use and can be installed

with very little trouble. Add products whenever it suits your needs or your budget.

## TaHoma Hub

The Somfy TaHoma hub allows control of your garage door and other compatible home items from your tablet, pc or smart phone. The door must be in line of sight to ensure safe operation.

The TaHoma is the beating heart of Somfy Smart Home. This smart box not only allows you to control individual products remotely via smart-phone, it also enables you to create scenario's involving groups of products and connects you to your home at all times.

A typical scenario might include linking your lights, window shutters and garage door together in a 'leave' scenario and Somfy Smart Home will take care of everything. The window

shutters close, all the lights are turned off and the garage door automatically closes behind you.

## Smart living starts with AlluGuard's Somfy Smart Home.



# Discover the possibilities of Somfy Smart Home!

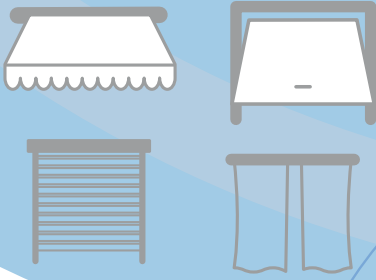

Somfy motorised products

## TaHoma®

Compatible Services



Compatible Protocols



Compatible equipment depending on your home configuration



Garage door Sensor\*



Outdoor motion sensor\*



Movement detector RTD - Small pets\*



Movement detector RTD - Large pet\*



Lighting receiver indoor ON/OFF



Lighting receiver outdoor ON/OFF



TaHoma security remote control\*



Remote controlled socket



Water Leakage Sensor\*



Sun sensor\*



Scenario player\*



Indoor security camera



Outdoor security camera (also in Anthracite)



Indoor movement detector\*



Opening detector\*



Smoke detector\*



Temperature sensor\*



Indoor siren\*

\*BATTERY OPERATED - NO HARD WIRING REQUIRED!

You choose how to control your smart home: by smart-phone, tablet, computer or your connected watch.



### Height measurement guide

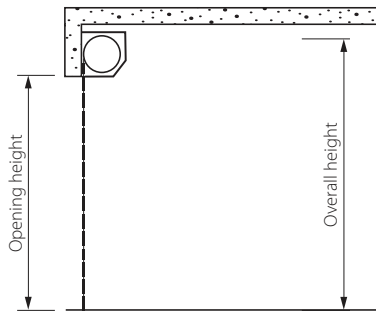

### Width measurement guide

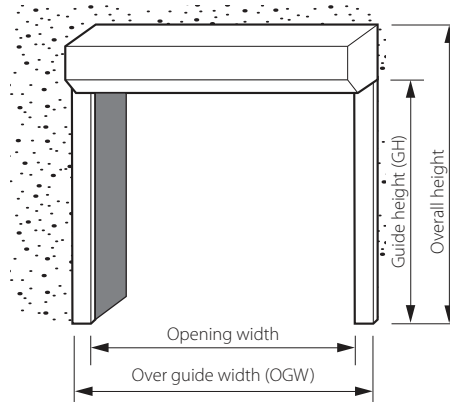

### Box end details

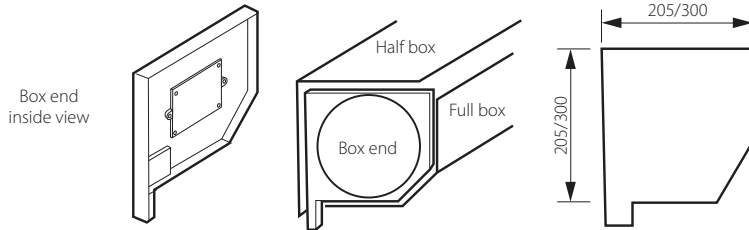

Full and half box (optional extra)

### Guide specifications

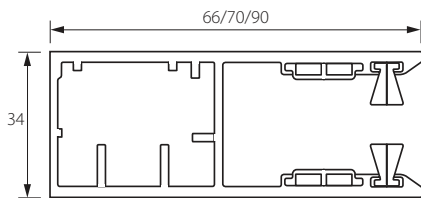

### Fixing options

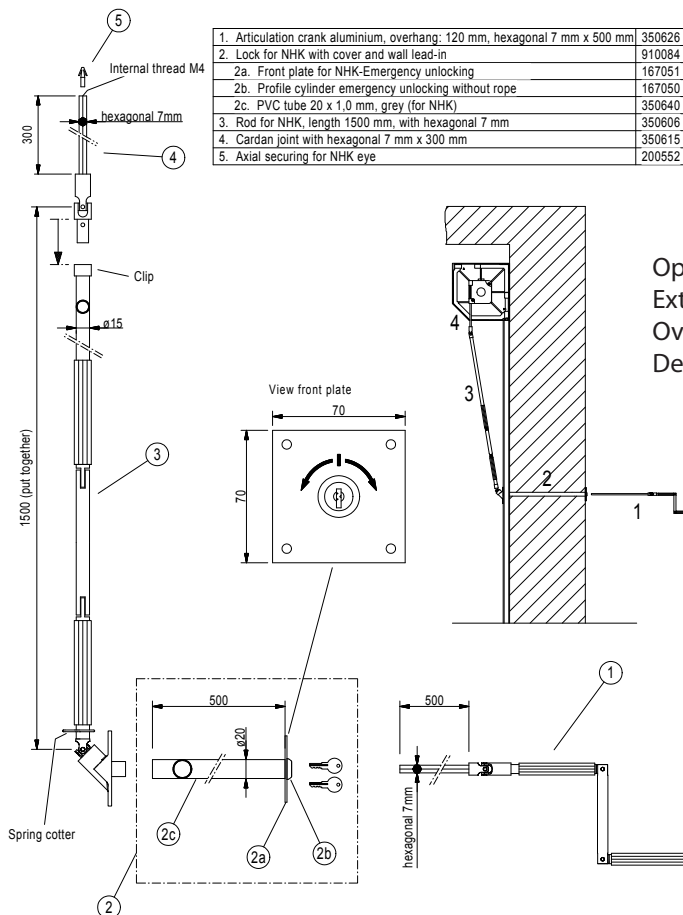
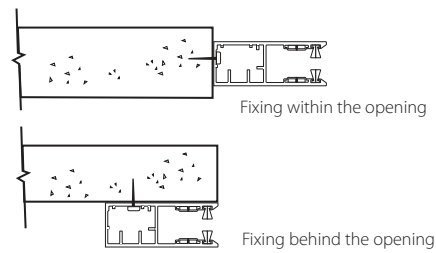

Optional  
External  
Override  
Detail

Technical

AlluGuard 77

AlluGuard 55

# Also from AlluGuard...



## Insulated Sectional Garage Doors

### Exceptional performance...

Insulated sectional garage doors provide exceptional performance when it comes to insulation and draught reduction.

They're not short on good looks either with a stunning choice of styles finishes and window options!

Just ask for a copy of the brochure or view online at [www.alluguard.co.uk](http://www.alluguard.co.uk).

### Rechargeable, simple...

Portal Powered Blinds from AlluGuard is a simple... ..but brilliant concept. Every blind includes a rechargeable Lithium Ion battery for wire-free powered operation.

Remote control, smart home control... ..and you can also control with simple voice commands using Amazon Alexa.

Just ask for a copy of the brochure or view online at [www.alluguard.co.uk](http://www.alluguard.co.uk).



## Portal Powered Blinds

### You control the sun!...

SolidScreen from AlluGuard brings you privacy, sun protection and style. It's never been easier, more attractive and made to last!

Just ask for a copy of the brochure or view online at [www.alluguard.co.uk](http://www.alluguard.co.uk).



## SolidScreen Sun Protection Window Screens

# Safety - CE marking

It is against the law to install a power operated garage door in the UK without complying with The Machinery Directive.

To comply with the Machinery Directive both the door and the motor and controller used in the installation must have a Declaration of Incorporation from the manufacturer.

On completion of the installation the installer must provide a Declaration of Conformity and apply a CE mark giving details of the installation to the door / motor and controller combination, which is now classed as a machine.

The installer must issue to the customer a Declaration of Conformity, maintenance and operation instructions on the completion of the installation.

The installer must hold copies of both the Declaration of Incorporation and the Declaration of Conformity on a technical file for inspection by the relevant authorities.

If any of the above requirements are not fulfilled the Installation is illegal and may be unsafe.

Please ensure for your own safety and peace-of-mind that whoever installs your electric motor and controller is both willing and able to fulfil these requirements; if they are not – do not use them.

Choose a member of the DHF Garage Door Installer Group who CAN and WILL install your motor and controller safely and legally.



## Peace-of-Mind Warranties

(a) AlluGuard roller garage doors are guaranteed against any form of manufacturing defect for a period of 2 years from the date of original purchase.

(b) AlluGuard tubular motors are guaranteed against any form of manufacturing defect for a period of 5 years. Other electrical and mechanical elements within the control system are guaranteed for a period of 5 years.

(c) AlluGuard roller garage doors exterior finish is guaranteed to provide an effective weatherproof membrane that will resist perforation of the substrate from the weather side due to corrosion for a period of 5 years. Externally fitted reverse roll AlluGuard roller garage doors will resist perforation of the substrate from the weather side due to corrosion for a period of 2 years. Colour change or fade to the exterior surface will be limited and uniform during the guarantee period.

Guarantees are subject to conditions - please visit [www.alluguard.co.uk/warranty](http://www.alluguard.co.uk/warranty) for full details.



AlluGuard Limited  
Rotherham Road, Parkgate, Rotherham S62 6FP  
t: 01709 529 723  
f: 01709 524 577  
e: [customerservice@alluguard.co.uk](mailto:customerservice@alluguard.co.uk)  
w: [www.alluguard.co.uk](http://www.alluguard.co.uk)

AlluGuard reserve the right to alter specifications to design and manufacture without notification.  
All specifications are correct at time of publication, errors and omissions excepted. October 2021