

The Garador Range

NEW Slategrain surface finish on sectional garage doors







Up & Over garage doors	4
Canopy and retractable lifting gear	6
Steel panel doors	8
GRP panel doors	12
Timber panel doors	14
Steel frame and SBD options	16
Side hinged garage doors	18
Side hinged garage door functions and features	24
Up & Over garage door options	26
Sectional garage doors	28
Georgian and Linear designs	30
Security, insulation and features	31
Sectional garage door options	34
GaraMatic operators	36
BlueSecur app	40
GaraMatic operator accessories	42
Roller garage doors	44
GaraGlide	46
GaraRoll	47
Roller garage door options	48
FrontGuard entrance doors	52
FrontGuard functions and features	54
FrontGuard options	60

Since the company's policy is one of continuous improvement of its products, we reserve the right to make any alterations. Copyright. No part of this brochure may be copied or reproduced without our prior written permission.

Our doors are for residential purposes only and not for commercial use.



Superior quality up & over garage doors for every home

Garador's up & over garage doors are available in an extensive range of sizes that includes singles, doubles and made-to-measure. You can choose from two types of lifting gear to operate your garage door: canopy or retractable. Please see overleaf for further details.

Three different materials are on offer to suit your garage's individual requirements, these are: steel, timber or grp (glass reinforced polyester). Each material comes in a variety of designs and colours to suit.



All Garador up & over garage doors come with a Limited 10 Year Warranty

Canopy lifting gear

An up & over garage door with canopy lifting gear requires less space for opening, as there are no tracks running back into the garage. It is available in single door sizes up to 3049 mm wide and one-third of the door protrudes from the garage whilst in the open position.

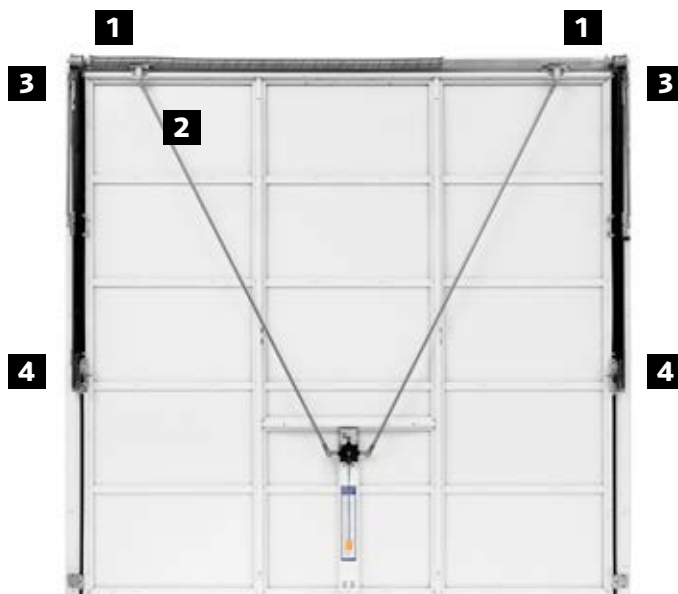

1 Two-point locking for security



2 Zinc coated torsion spring



3 Durable steel cables & cast alloy drum



4 Guide rail & anti-drop safety mechanism



If you are looking to automate your garage door with an electric operator, we recommend retractable lifting gear as it is ideally suited to electric automation.

Retractable lifting gear

An up & over garage door with retractable lifting gear opens along horizontal tracks that run back into the garage. It is available in single or double door sizes up to 5000 mm wide. When the garage door is in the open position, the bottom of the door panel sits flush with the opening.



1
Two-point locking for security



2
Pivot arms and triple spring system



3
Guide rails and roller assembly



4
Secure parking position

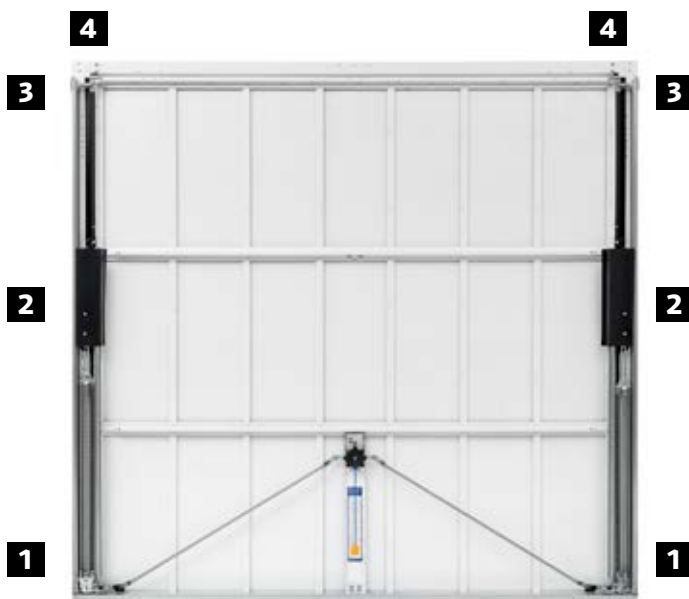

Retractable Plus lifting gear has specially designed lifting arms for narrow openings, which allow for maximum use of the clear passage.

Steel panel doors

Ribbed door designs have a classical appearance and blend in with most homes. Our wide-profiled doors are precision-engineered for durability and perfectly complement modern architectural design. Their tough and sturdy construction offers resilience against the elements and a design that will stand the test of time.



Carlton  available as an option



Horizon  available as an option



Salisbury  available as an option



Ascot



Windsor



Sutton



Wentwood



Sherwood

Our superb range of Georgian panel style doors will look good on any house type, whether modern or traditional. All have deep, crisp panel profiles, which give them solid and sturdy characteristics combined with an elegant appearance.



Georgian



Beaumont



Beaumont with windows



Cathedral

Design range

Our Design Range is stunningly modern and blends in with a minimalist design aesthetic. Doors are constructed from high grade galvanised steel and come in a variety of designs, with stainless steel embellishments. Supplied with brushed steel handle as standard.



100

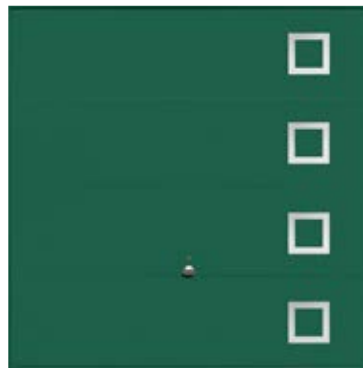

101

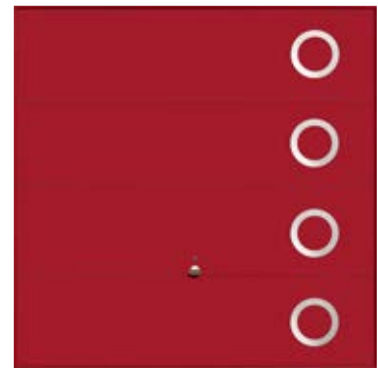

102



103

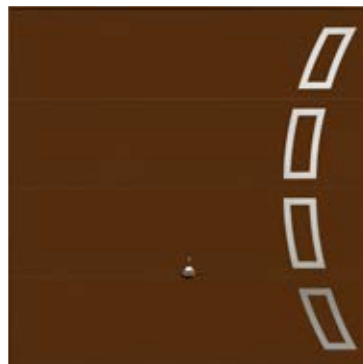

104



105

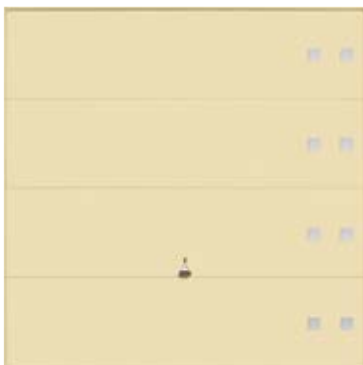

106

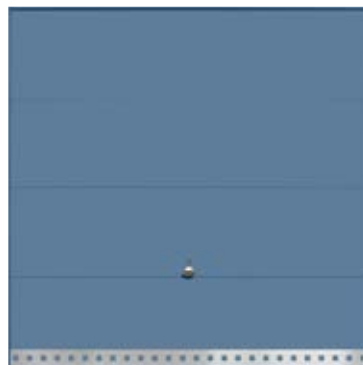

107



108

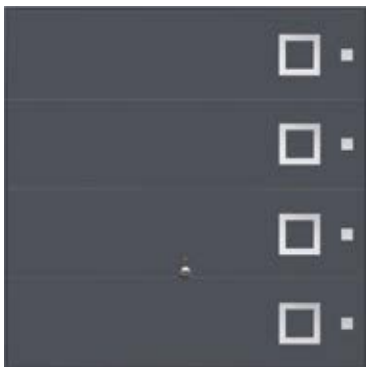

109



200

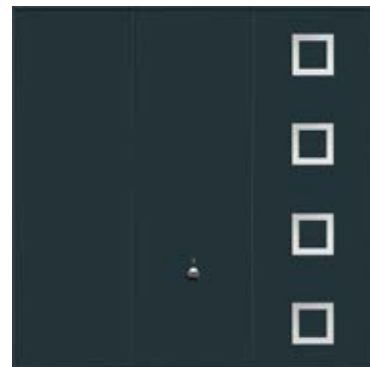

201



202



203



204



205



207

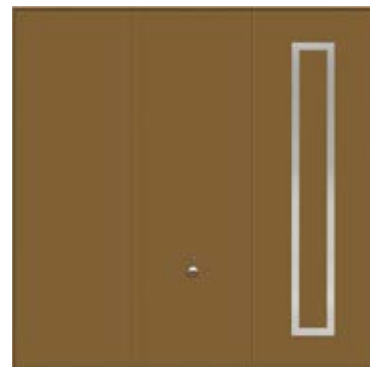

210

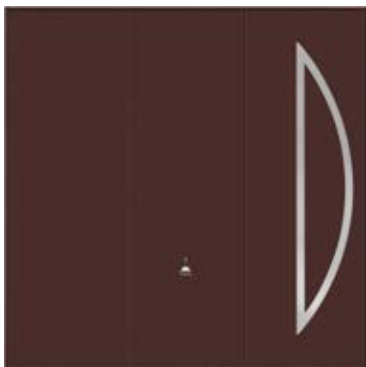

211

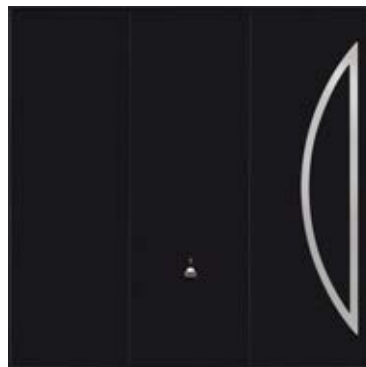

212

GRP panel doors

Our GRP panel doors are available in either a timber effect or gloss white finish. The timber effect designs have a woodgrain surface finish that imitates the texture of real wood, but unlike real wood it does not need to be treated or stained and is therefore low-maintenance.



Kenmore



Kenmore with windows



Glastonbury



Somerset



Penshurst



Swinton

The Arden and Stamford are only available in gloss white, utilising a UV protective gel coating developed for the marine industry to prevent door discolouration overtime. Thus the door will maintain its stunning white appearance for many years to come.



Arden



Arden with windows



Stamford



Stamford with imitation window

Timber panel doors

Choose from either Solid Cedar or Elizabethan style timber garage doors. Our Solid Cedar range is constructed from tongue and groove solid cedar boards that are held together with wooden dowel rods and a partial WBP plywood backing. Whilst our Elizabethan range is built using beautifully machined Western Red cedar and Okoume marine grade plywood backing. Full range of handle and stain options available.



Vertical Cedar



Horizontal Cedar



Sandhurst

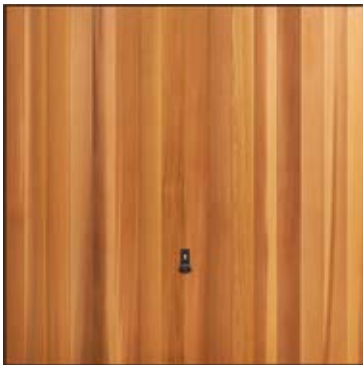

Hampton

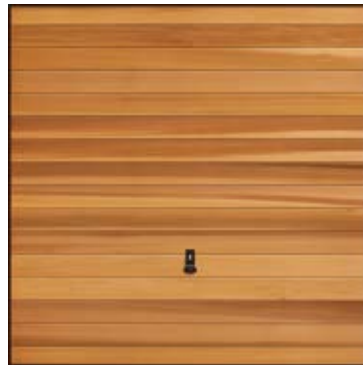

Countryman



Chevron Cedar



Barrington



Kingsbury



Ashton

Vertical and horizontal cedar doors are constructed using 83mm boards, whilst the Hampton and Countryman use 133 mm boards. A 5.5 mm thick partial plywood backing is applied to all solid cedar garage doors.

Whilst Cedar is a softwood, it contains natural oils that act as preservatives to help the wood resist insect attack and decay. These naturally self-protective qualities help it to withstand high-moisture areas without warping, cracking or rotting. It also means that the Cedar wood remains straight and flat, making it perfect for Garador doors. When properly finished and regularly maintained, Western Red Cedar will last for many years to come.



Addlington



Rochdale



Shaftesbury



Seymour



Wolsey



Tudor



Bosworth



Hinton



Grantham

All timber doors are built within a steel boundary chassis for added strength and the chassis itself is painted in Terra Brown (RAL 8028) as standard.



Additional options

Quick-fit steel frame

A steel frame provides a faster, more accurate way of fitting your Garador up & over garage door, as the frame is constructed to fit the size of your door perfectly. Furthermore, because the frame is constructed from galvanised steel it will last for many years to come, unlike a timber frame which may warp or rot over time.



Upgrade to Secured by Design

All SBD up & over doors come supplied with a galvanised steel frame as standard, which is quick and easy to fit and provides added structural strength and stability to the door and the opening.

1 Improved Lock Security

Additional steel plates have been added to the base corners of the door to protect the bottom locking system.

2 Lock Body Protection and Anti-Snap Cylinder

A reinforcing plate has been added to the lock body to prevent attacks against the locking mechanism.

3 High Security Bracing

There are now at least eight door braces rather than two at the back of the door for extra protection.







Introducing the Garador side-hinged garage door

Garador's side-hinged garage doors have been engineered with an intuitively simple and easy-to-use design. They are ideal for garages where frequent access is required to store and retrieve larger items such as bicycles or garden tools. A lever handle is used to operate the door and both door leafs open outwards providing clear and unrestricted space within the garage.

Choose from an extensive selection of standard and made-to-measure door sizes. Three different materials are on offer to suit your garage's individual requirements, these are: steel, timber or grp (glass reinforced polyester). Each material comes in a variety of designs and colours to suit. We also offer a range of matching garage side doors.

Modern appearance, classic steel design

Our steel side-hinged garage doors have a classic appearance that blends in with most homes. Choose from a range of traditional Georgian designs and more modern swage or wide profiled models.



Georgian



Beaumont



Beaumont with windows



Cathedral



Carlton



Ascot



Windsor

Gloss White and timber effect GRP finishes

Our GRP timber-effect side-hinged doors have a woodgrain surface finish that imitates the texture of real wood. The Arden and Arden with windows come in a tasteful, resilient white gloss finish for a smooth and stylish finish.



Arden



Dorchester



Kenmore



Somerset

Quality craftsmanship and exquisite timber designs

Our timber side-hinged garage doors combine quality craftsmanship with the exquisite beauty of real wood. We use the finest materials to build a door that will last for many years to come. Choose from Solid Cedar designs, constructed from Western Red Cedar, or Elizabethan ranges built from marine grade plywood and solid cedar.



Ashton



Ashton Chevron



Chevron Cedar



Horizontal Cedar



Seymour



Tudor



Vertical Cedar



Kingsbury

Steel and timber garage side doors

To further enhance the appearance of your garage we can now provide a side door to match many of our Up & Over designs. These doors are produced in much the same way as our Up & Over doors, showing the same details and finished in exactly the same colour to provide a perfect match.



Georgian



Beaumont



Beaumont with windows



Cathedral



Carlton



Ascot



Windsor



Half Chevron Left



Half Chevron Right



Horizontal Cedar



Vertical Cedar



Kingsbury



Seymour



Robust and reliable performance

Our side-hinged garage doors have been designed to provide years of reliable use and excellent security. A 75 mm wide galvanised steel door frame gives a strong and stable door construction. The hinges are concealed in the frame reducing their vulnerability to burglars and providing a seamless appearance across the surface of the door, as there are no hinge knuckles protruding.



1 Two-point locking for security



2 Door stays and dampeners



3 Sturdy weatherproof rubber seals all round



4 Aluminium threshold

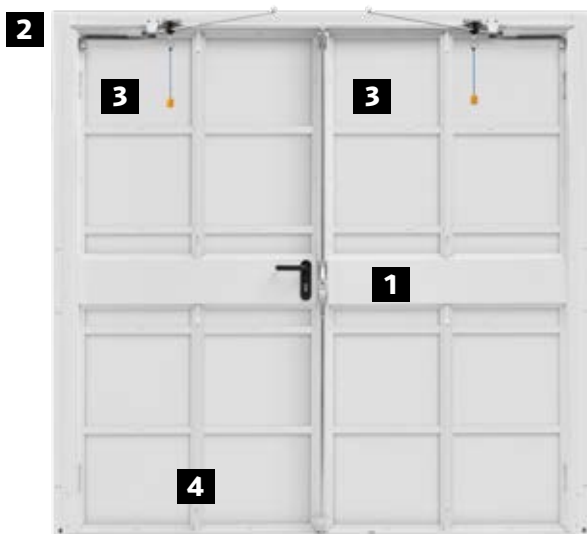



3-way adjustable hinges allow the door position to be precisely adjusted for a smooth door action and a tight close against the rubber seal.

Colour options















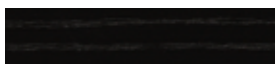

COLOUR OPTIONS FOR STEEL PANEL, SIDE-HINGED AND GARAGE SIDE DOORS

	
Traffic White (RAL 9016)	Moss Green (RAL 6005)
	
Jet Black (RAL 9005)	Pigeon Blue (RAL 5014)
	
Terra Brown (RAL 8028)	Steel Blue (RAL 5011)
	
Window Grey (RAL 7040)	Signal Blue (RAL 5005)
	
Agate Grey (RAL 7038)	Ruby Red (RAL 3003)
	
Light Grey (RAL 7035)	Light Ivory (1015)
	
Stone Grey (RAL 7030)	Chartwell Green (BS 4800)
	
Anthracite Grey (RAL 7016)	Golden Brown
	
Slate Grey (RAL 7015)	Burgundy Brown
	
Fir Green (RAL 6009)	

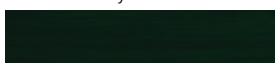
COLOUR OPTIONS FOR TIMBER EFFECT STEEL PANEL GARAGE DOORS

Foil-coated Rosewood

Foil-coated Golden Oak

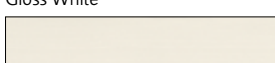
COLOUR FINISHES FOR GRP PANEL DOORS, SIDE HINGED AND GARAGE SIDE DOORS

	
White	Teak
	
Magnolia	Rosewood
	
Light Oak	Golden Brown
	
Red Mahogany	Ebony
	
Dark Mahogany	Anthracite Grey
	
Bleached Oak	Green
	
Dark Oak	Blue
	
Irish Oak	Gloss White
	
Honey Beech	Gloss Magnolia

FULLY FINISHED STAIN FOR TIMBER PANEL, SIDE-HINGED AND GARAGE SIDE DOORS

	
Light Oak	Walnut
	
Antique Oak	Chestnut
	
Mahogany	Ebony

Printed colour samples are as accurate as printing techniques allow.

Window and handle options



1

2

3



4

Window options for steel panel, side-hinged and garage side doors

- 1 Standard (only for Beaumont design)
- 2 Cross (only for Beaumont design)
- 3 Diamond (only for Beaumont design)
- 4 Salisbury black pane (optional)

Glazings are available in clear or crystal

Window options for GRP panel doors



5

6

7



8



9



10

- 5 Black Non-Translucent with Border and Diamond Leading
- 6 Black Non-Translucent
- 7 Clear Perspex
- 8 Stippled Perspex with Diamond Leading
- 9 Stippled Perspex with Square Leading
- 10 Stippled Perspex

Glazings above are available in smoked or semi-translucent

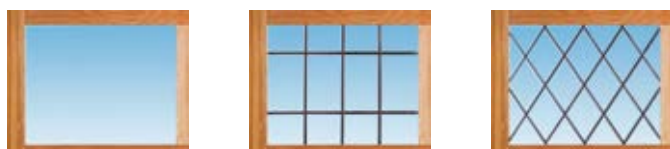

11

12

13

Window options for timber panel, side-hinged and garage side doors

- 11 Plain
- 12 Georgian style leading (only for Sandhurst design)
- 13 Diagonal leading (only for Sandhurst design)

Glazings are available in clear or crystal



14

15

16

17

Diecast handle options for steel panel doors

- 14 Chrome effect
- 15 White
- 16 Brass effect
- 17 Brushed steel effect*

* Supplied as standard on Design range doors



18

19

20

Diecast handle options for GRP and timber panel doors

- 18 Chrome effect
- 19 White
- 20 Brass effect



21

22

23

Lever handle options for steel, timber and GRP side-hinged garage doors and garage side doors

- 21 Chrome effect
- 22 White
- 23 Black synthetic (outside knob, inside lever)





Secure and thermally insulated sectional garage doors

Garador sectional garage doors are made up of separate sections that vertically lift and then run on tracks back into the garage. This allows for closer parking to the garage door as there is no "swing out". The door has Premium 42 mm thick insulated sections that are ideal for integral garages.

Four different door designs, six surface textures and a selection of RAL colours, mean there are an extensive range of door combinations, to suit homes with either modern or traditional architecture. Please see over leaf for further details.



All Garador sectional garage doors come with a Limited 10 Year Warranty

Georgian and Linear designs

Choose from four different sectional garage door designs, each available in a variety of surface finishes and colours as detailed below.

Georgian



Surface options

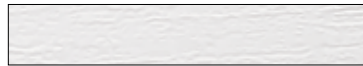

Woodgrain

Linear Small

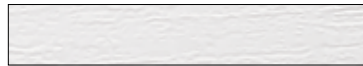

Woodgrain

Linear Medium

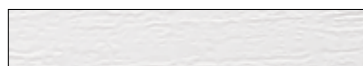

Woodgrain

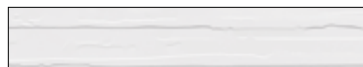

Slategrain



Sandgrain

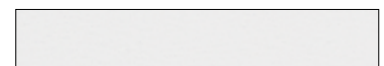

Silkgrain



Timber effect



Metallic finish

Linear Large

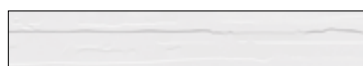

Slategrain



Sandgrain

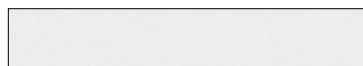

Silkgrain



Timber effect



Metallic finish



Excellent insulation and thermal performance

Our Premium sectional garage doors provide great thermal insulation, which is perfect for integral garages. Each door section is 42 mm thick and filled with CFC-free PU rigid foam. This is encased by a steel skin on both sides of the panel, for a strong and stable construction, and a seal between each section to prevent drafts.



Excellent security with anti-lift kit

For Garador automated sectional garage doors, the anti-lift kit in the operator's boom stop, prevents forced opening from unwanted intruders. GaraMatic operator is required. Furthermore, any Garador premium sectional garage door that is fitted behind the opening and automated with a GaraMatic operator can be accredited with Secured by Design status.

Please note, the door must be unmodified and registered with Garador to qualify for Secured by Design accreditation.



Full drive-through width

The design of Garador's sectional garage door allows you to maximize drive-through width, as there are no lifting arms taking up precious space, as is the case with a traditional up & over garage door. This makes it much easier to park larger modern vehicles such as 4 x 4 s in your garage.

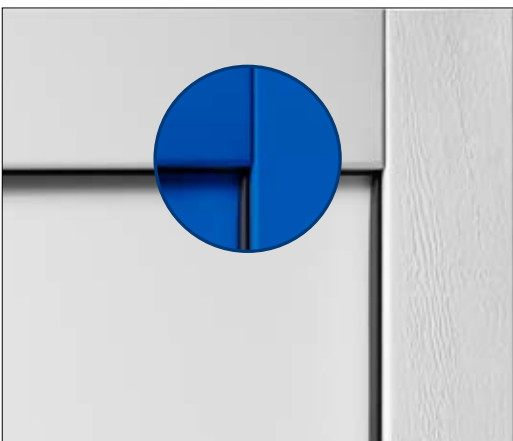

Matching appearance of frame and door leaf

The colour and surface texture of Garador's sectional door frame and leaf are perfectly harmonised for a uniform appearance. Top fascia panel and frame cover profiles are supplied in white woodgrain surface finish as standard, colour match available as an option for coloured doors.

Expert engineering, designed for everyday use

Our sectional garage doors are expertly engineered for everyday use, with a range of features that ensure outstanding thermal performance, security, safety and longevity.



It's important to factor in how much headroom you have inside the garage, as this could affect the type of garage door you can fit. Our sectional garage doors with tension or torsion (low headroom) lifting gear, require just 100mm minimum headroom.



BS EN 13241 Compliant
All Garador garage doors comply with the latest European safety standards.

Expert engineering



Enhanced insulation with ThermoFrame
Garador's ThermoFrame provides up to 15% improved thermal insulation. The plastic profile, that's fitted to the door frame, creates a thermal break between the frame and brickwork. Extra rubber seals on both sides of the door and on the top door section, contribute to a better overall seal.



Durable paint finish
A durable powder-coat paint finish ensures the surface of your door is protected for the long-term. Choose from a selection of surface textures on page 34.



Flush fitting panels
A flush-fitting fascia panel is the most elegant solution for an invisible transition between the panel and door leaf. When the door is closed, the top door section is flush with the panel. Please note, intermediate seals only on 42 mm Premium insulated sectional doors.



Floor seal
A large bottom weather seal accommodates any slight inconsistencies in the surface of your floor, creating a tight seal and preventing drafts.



Outer edge and intermediate seals
Flexible and weather resistant seals on all four sides of the door help to keep the wind and rain outside. Intermediate seals between every section joint, further enhance the door's thermal insulation.



Plastic frame footer
A plastic protective cover is fitted to the base of both sectional door frame legs. This provides long-term protection against corrosion that might be caused by humid acids or salts, in a part of the door that is susceptible to rust.

Safety features



Side hand guard
The side tracks are completely enclosed, from top to bottom, so there are no gaps between the door leaf and the frame where fingers could get trapped.



Anti-drop safety device
Garador sectional doors with either tension or torsion lifting gear, have an integrated anti-drop safety device. These systems prevent the door from crashing down in the event of a spring or cable failure.



Pinch protection
Each of the door sections have been designed specifically to prevent finger trapping. Each section rebate is optimally shaped as a finger protection profile that is effective both between the door section and on the hinges.



Safe door travel
The combination of adjustable rollers, solid rollerbrackets and safety tracks, prevents the door sections from derailing.

Colours and surface finishes



16 STANDARD COLOURS FOR WOODGRAIN, SLATEGRAIN AND SILKGRAIN SURFACE

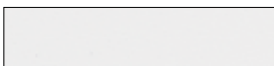

Traffic White (RAL 9016)



Grey Aluminium (RAL 9007)



White Aluminium (RAL 9006)

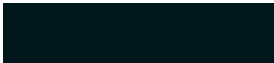

Jet Black (RAL 9005)



Terra Brown (RAL 8028)



Window Grey (RAL 7040)



Quartz Grey (RAL 7039)



Light Grey (RAL 7035)



Stone Grey (RAL 7030)



Anthracite Grey (RAL 7016)



Slate Grey (RAL 7015)



Basalt Grey (RAL 7012)



Fir Green (RAL 6009)



Moss Green (RAL 6005)

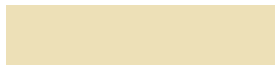

Light Ivory (RAL 1015)



Titan Metallic (CH 703)



Woodgrain

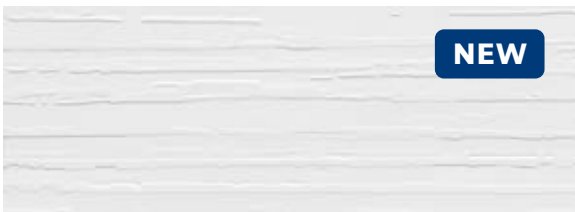

Slategrain

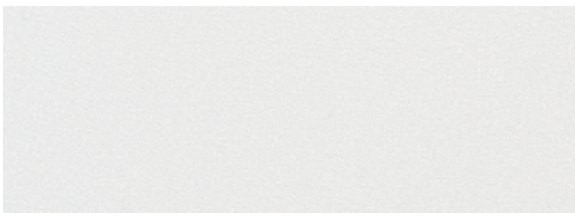

Sandgrain



5 TIMBER EFFECT SURFACE FINISHES



Golden Oak



Rosewood



Dark Oak



Night Oak



Winchester Oak



2 STANDARD COLOURS FOR SANDGRAIN SURFACE

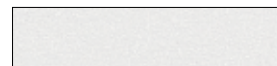

Traffic White (RAL 9016)



Anthracite Grey (RAL 7016)

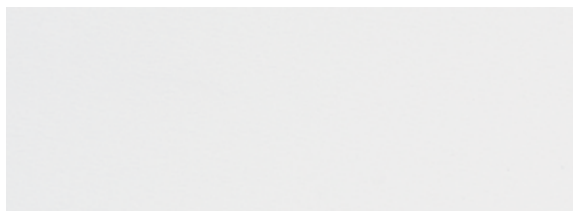

Silkgrain



Timber effect

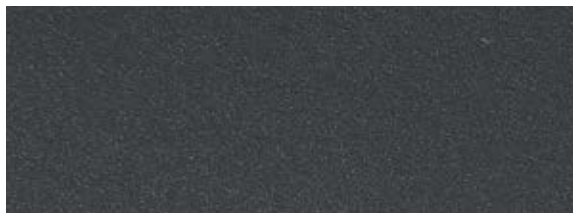

Metallic finish

In addition to the above standard colours we can also paint your door to any RAL colour to suit your individual requirements.

Printed colour samples are as accurate as printing techniques allow.

Window and handle options



1



2



3



4



5



6



7

Window options for Georgian designs, Linear Medium and Linear Large designs

- 1 Standard
- 2 Diamond
- 3 Cross
- 4 Sunrise*

*The Sunrise design varies depending on the number of windows (only available on Georgian doors).

Window option for all Linear designs

- 5 Linear 1

Window options for Medium and Large Linear designs

- 6 Linear 2
- 7 Linear 3

Window frames and rails made of synthetic material, white as standard, colour-match to the door is optional. Window frames for timber-effect doors are colour-matched as standard.



1

2

3

4

Design handles options

- 1 Black synthetic material
- 2 White
- 3 Brown finish
- 4 Brushed stainless steel

GaraMatic operator features

Our range of GaraMatic operators have been designed to provide years of reliable service and the convenience of opening your garage door at the touch of a button. Energy efficient LED lighting, a power saving mode and smartphone connectivity are perfect for modern lifestyles.

	GaraMatic 9	GaraMatic 10	GaraMatic 20
Opening speed	20 cm/ second	25 cm/ second	25 cm/ second
Pull and Push Forces	600 N	650 N	750 N
Peak Force	750 N	800 N	1000 N
Maximum door width	5000 mm	5500 mm	5500 mm
Integral LED light	10 LED lights	20 LED lights	30 LED lights
Adjustable LED light for energy efficiency		•	•
Automatic safety reversal	•	•	•
Anti-lift kit	•	•	•
Remote status query	•	•	•
Bi-directional radio technology	•	•	•
868 MHz high-frequency signals	•	•	•
Soft start and soft stop	•	•	•
Low Power Consumption (< 1 watt)	•	•	•
Self-closing timer		•	•
Integral light strobes during operation		•	•
Half-open function for ventilation (only with climate sensor)		•	•
Third-open function for ventilation (only with climate sensor)		•	•
Integrated bluetooth receiver for controlling operator using Garador App		•	•
HCP interface to connect accessories or external SmartHome systems (i.e. Apple HomeKit)		•	•

Bi-directional radio technology

Our operators use bi-directional FM radio signals, that have the same 128-bit encryption used by banks for online security. This technology makes the electric operator even more secure and ensures a more reliable signal and extended range.





GaraMatic 9
peak force 750 N
incl. two 4-button hand transmitters



GaraMatic 10
peak force 800 N
incl. two 4-button hand transmitters



Integrated bluetooth receiver as standard



GaraMatic 20
peak force 1000 N
incl. two 4-button hand transmitters



Integrated bluetooth receiver as standard



Engineered for security and convenience

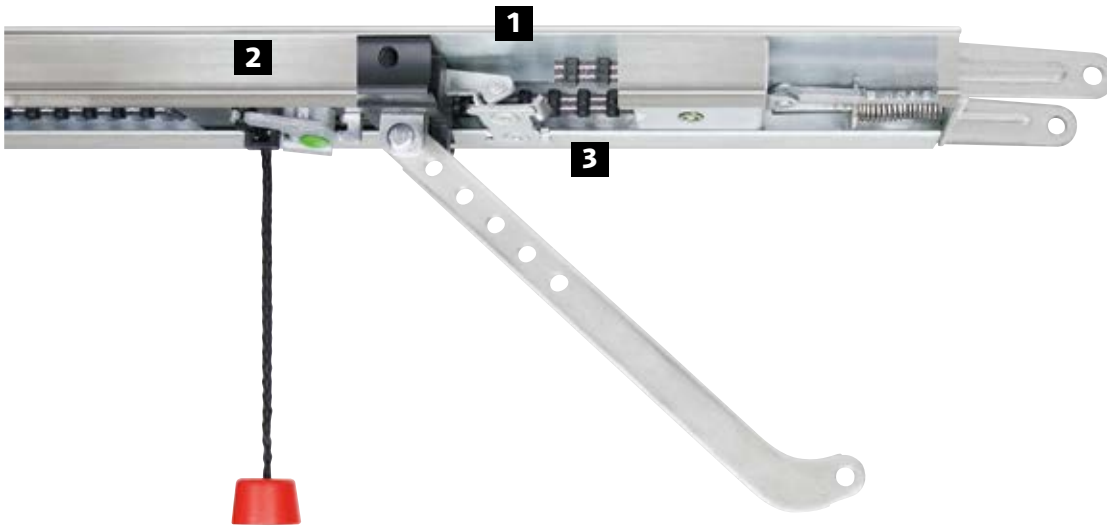

1 Mechanical lock inside boom for security. As soon as the garage door is closed, the anti-lift kit automatically engages in the operator's boom stop, preventing any forced entry. This is a mechanical process which functions without the need for a power supply.

2 Emergency release from inside. The pull handle provide an emergency release, so the door can be conveniently opened from the inside in the event of a power failure.

3 Maintenance-free tooth belt. Unlike operators with a chain or spindle design, Garador's kevlar toothed belt does not require grease or lubricants and is therefore maintenance free. The belt is reinforced with aramid fibres, so it is tear resistant and quiet.



LED Lighting for energy efficiency
GaraMatic operators feature an integral LED light for energy efficiency. Furthermore, each model has a low power consumption of less than 1 watt in stand-by mode.



Third ventilation opening position
In addition to the half-open ventilation position, our GaraMatic operators also have a one-third ventilation position. This feature is only activated with the use of the climate sensor.



Easy to connect
A larger and more accessible connection compartment on the back of the operator, makes the integrated circuit board easier to access when connecting accessories or smarhome systems.

Control your garage door with your smartphone

We use our smartphones everyday to talk, type messages and browse the internet. With Garador's new BlueSecur app, you can quickly and conveniently operate your garage door using your smartphone too. An integrated bluetooth receiver provides a secure, reliable connection. The bluetooth receiver can be turned on or off.

Our range of genuine GaraMatic operator accessories, such as hand transmitters, code switches and wall consoles, are still available for a more traditional control device.

Garador BlueSecur App

- Control your GaraMatic operator (open/ close/ open partially/ light) from your smartphone.
- Quick and easy-to-use interface.
- Push notifications when receivers come into range.
- Free download from App store or Google Play.
- One free user key included. Others available via in-app purchase.

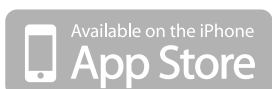

Automatic safety reversal

For your safety, all GaraMatic operators comply with the latest European safety standards (BS EN 13241). They have an automatic safety reversal feature, which uses force limitation, to recognise when there is an obstruction in the path of the door, at which point the door will stop and reverse allowing the obstruction to be removed.



Check the position of your garage door

All GaraMatic operators have a remote status query feature*, so you no longer have to go outdoors in all kinds of weather to check that your garage door is closed. Simply press the button on your hand transmitter and the colour LED will indicate the door position.

* 5-button bi-directional hand transmitter required



Display of 5-button hand transmitter
1 Door is open
2 Door is closed



GaraMatic operator accessories



5 button Bi-directional hand transmitter

4 Control buttons, plus a status function. Available in matt black texture, high-gloss black or white.

The 5 button hand transmitter comes with a remote status query feature so you can check whether your garage door is closed at the press of a button.



2 button Bi-directional hand transmitter

Features 2 control buttons and an eyelet for a key ring. Available in high-gloss black or white, green, red, carbon fibre, aluminium and wood effect.



4 button Bi-directional hand transmitter

4 Control Buttons. Available in matt black texture with chrome or black end caps.

Features 4 control buttons and an eyelet for a key ring. The 4 button hand transmitter can be programmed to open up to four garage doors.



1 or 4 button Bi-directional hand transmitter

1 or 4 Control Buttons. Available in high-gloss black.

The 1 button hand transmitter combines convenience and style with the simplicity of a single button to operate your garage door.

The 4 button hand transmitter can be programmed to open up to four garage doors.



Hand transmitter station

Available in high-gloss black and white.

The hand transmitter station provides a handy and stable solution for storing your 5 button, 4 button or 1 button remote hand transmitter when it is not in use.



Transmitter for cigarette lighter

1-channel (fig. left)
2-channel (fig. right)

One or two key functions.
For insertion into Car cigarette lighter.
Battery operated.

In car transmitter plugs directly into your car cigarette lighter and can be programmed to open up to two garage doors.



Radio code switch FCT 3 BS

For 3 functions.
With illuminated buttons.

Surface mounted fitting possible, plastic housing in Light Grey (RAL 7040)



Radio code switch FCT 10 BS

For 10 functions
With illuminated buttons and hinged cover.

Surface mounted fitting possible, plastic housing in Light Grey (RAL 7040). Hinge cover painted in White Aluminium (RAL 9006).



Wired wall console IT3 B

3 functions
Supplied with 7 metre connecting lead (2 wires)

Button for opening and closing garage door. Plus additional buttons for light (on/ off) and operator (on/off). Painted in Pure White (RAL 9010).



Wireless wall console FIT 2 BS

3 button functions

Two push buttons for controlling up to 2 garage doors, via radio signal. One additional button for on/off function of connected external elements. Painted in Pure White (RAL 9010).



Internal push button IT 1b-1

Large, illuminated button for convenient opening of the door.

Plastic housing in Pure white RAL 9010



Space saving and convenient roller garage door designs

Garador roller garage doors open vertically and roll into a compact box at the head of the garage door opening, requiring minimal space inside the garage. This space-saving design means you can make full use of the space inside your garage, as the ceiling area remains free and can be used for lighting or additional storage space.

Choose from two different models, the GaraRoll and the GaraGlide. The GaraRoll is our premium offering, with a chain driven motor and pressure sensitivity built-in, whilst the GaraGlide utilises a tubular motor and optical-sensor at a significant price advantage.



All GaraRoll and GaraGlide roller garage doors come with a Limited 10 Year Warranty.

GaraGlide

The GaraGlide is electrically automated, with a tubular motor positioned at the end of the barrel, inside the box cover. It is equipped with a mechanically adjustable end-of-travel position, to set the doors open and close parameters. Supplied with crank handle for emergency release in case of power failure. Comes with two 2-button standard hand transmitters.



Control panel with integral LED light



Full box cover as standard



Mechanical stop for security



Manual limit setting



Rubber floor seal and brush seals in guide rails



Wired optical sensor for safety

GaraRoll

The GaraRoll is electrically automated with a chain driven operator and unique spring balanced system, minimising strain on the motor and ensuring a long service life. As the operator incorporates force limitation technology (pressure sensitivity), it automatically recognises obstructions and safely reverses, making an additional closing edge safety device unnecessary. Comes with two 4-button bisecur hand transmitters, for enhanced security and signal range.



Control panel with integral LED light



Full box cover as standard



Pull cord emergency release in case of power cut



Spring assisted for safety and longevity



Rubber floor seal and brush seals in guide rails



Mechanical stop for security



Automatic safety reversal



DuraBelt anti-scratch system

Additional options



Additional fascia panel



External emergency release

GaraGlide

- Wireless optical sensor (batteries required).
- Upgrade to bisecur radio technology (retrofitting unavailable).
- Additional fascia panel. Used to stabilise main fascia panel, always required when fitting between opening.
- External emergency release (open the door using crank handle from outside).
- An electronic limit setting is programmed through the control panel for quick setup.



Upgrade to bisecur radio technology



Electronic limit setting



Wireless optical sensor (batteries required)

GaraRoll

- Additional fascia panel. Used to stabilise main fascia panel, always required when fitting between opening.
- Emergency battery. Emergency power for up to 18 hours/ max. 5 door cycles.
- Chamfered bottom profile. For angled floor surfaces, supplied in Jet Black (RAL 9005).
- Option of manual operation. Manually operate door by hand, without need for hand crank.
- Exterior door release. Recommended when there is no second entrance to your garage.
- Audible intrusion alarm. Alarm with 110db sound, for security and peace of mind.



Additional fascia panel



The emergency battery



Chamfered bottom profile



Option of manual operation



Exterior door release



Audible intrusion alarm

Colour and profile options

The full range of color options and timber effect finishes are available to choose for either the GaraRoll or GaraGlide roller garage doors.

16 STANDARD COLOUR FINISHES



2 TIMBER-EFFECT FINISHES (FOIL COAT OR DECO PAINT)

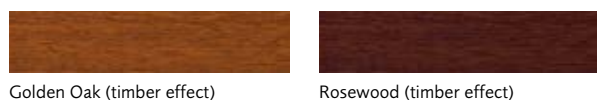

Profile with thermal insulation

The aluminium profiles are 77 mm high and are filled with polyurethane rigid foam for strength and a quiet door travel.

Window

Add a window for an individual design and the use of daylight in your garage. The number of elements depends on the respective door width. A maximum of ten profiles can be fitted with glazings in each door.

Ventilation grilles

Ventilation of your garage improves the room climate and prevents mould. A maximum of ten profiles can be used for each door.



Printed colour samples are as accurate as printing techniques allow.

* Please note, Anthracite Metallic (Noir 2100 Sable) is classed as a special colour for GaraGlide roller doors.



	GaraGlide	GaraRoll
Electrically operated door design	Tubular motor	Chain driven operator
Automatic safety reversal	Optical sensor built into floor seal	Force limitation built into operator
Standard emergency release	Crank handle	Pull cord
Hand transmitters	2-button standard	4-button bisecur
Maximum door width	5000 mm	6000 mm
Maximum door height	3100 mm	3100 mm
Door curtain (77 mm aluminium profile, PU foam filled)	•	•
Box cover as standard	•	•
Mechanical lock on barrel	•	•
Windlocks	•	•
Control panel with integral LED light	•	•
Suitable for fitting behind the opening	•	•
Suitable for fitting between the opening	•	•
DuraBelt anti-scratch system		•
Tension spring assembly		•
Low power consumption		•
Soft start and stop (enhanced service life)		•
Built-in bluetooth receiver and compatible with BlueSecur app		•
Optional extras		
External roller design	•	•
Additional fascia panel	•	•
Fitting compensation set	•	•
Exterior door release	•	•
Emergency battery		•
Manually operated door		•
Chamfered bottom profile		•
Audible intrusion alarm		•





FrontGuard entrance doors Thermally efficient and secure

Our FrontGuard entrance doors offer exceptional thermal insulation and security. This is achieved through a heavily insulated door panel, thermal breaks built into the frame and rubber seals on both the door leaf and frame. As well as 5-point locking as standard and 3 additional security bolts on the hinges, making it practically impossible to force the door open.

The Garador FrontGuard range is comprised of three different collections:

- Modern.
- Contemporary.
- Classic.

The wide range of designs, colours and glazing options allow you to create a door that perfectly matches your property. We also offer a range of FrontGuard doors to perfectly match a garage door from the current Garador range.

Choose from two variations of FrontGuard door

Choose from two variations of entrance door, FrontGuard 46 or FrontGuard 65. Our FrontGuard 46 doors provide excellent thermal performance with a 46mm thick PU-foam filled door panel and FrontGuard 65 has a further enhanced door design at 65mm thick.



FrontGuard 46

FrontGuard 65



1

PU foam filled door leaf with thermal break.

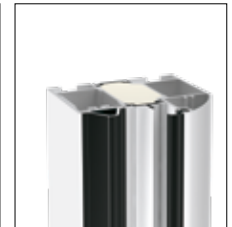

2

60mm aluminium frame (FrontGuard 46) or 80mm aluminium frame (FrontGuard 65). Both with built in thermal break.



3

Fully adjustable 3-way hinges.



4

5 point security locking.



5

Stainless steel internal handle.



6

20mm plastic and aluminium threshold, with rubber seals.



Modern designs

Our modern design FrontGuard doors have a superb high gloss surface finish. A flush fitting appearance on the interior and exterior, as well as a stainless steel glazing frame, underscore the door's elegant look.



FGS 600



FGS 700



FGS 750



FGS 800



FGS 810



FGS 820



FGS 850



FGS 900

Contemporary designs

The contemporary series of FrontGuard steel entrance doors feature modern accents to provide a new and contemporary design. A harmonious door appearance is created with a round-style composite glazing frame.



FGS 010



FGS 015



FGS 515



FGS 020



FGS 025

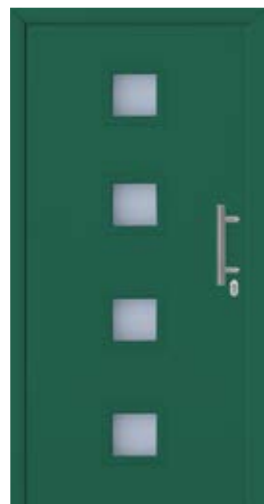

FGS 030



FGS 040



Break in resistance

The FGS 700 / 900 / 010 / 015 and 100 FrontGuard door models come optionally without side elements and transom lights with RC2 equipment. The FrontGuard 65 range, including those with side elements and transom lights, are available with RC2 equipment as an option. The doors are also approved for fitting either opening inwards or outwards of the opening.



Classic designs

With their traditional appearance, our Classic design FrontGuard doors complement both modern and more traditional architecture. The profile style, with its composite glazing frame, perfectly blends in with the classic panel look.



FGS 100



FGS 200



FGS 400



FGS 410 *



FGS 430 *



Consider the position of your entrance door. If it leads into a hallway which lacks natural light, a glazed door model might be preferable. But if you live in a busy urban street, a door without windows gives you more privacy.

* Only available in White (RAL 9016)

Colour and handle options

21 STANDARD COLOURS FOR MODERN, CONTEMPORARY AND CLASSIC DOORS



5 TIMBER EFFECT SURFACE FINISHES FOR MODERN AND CONTEMPORARY DOORS

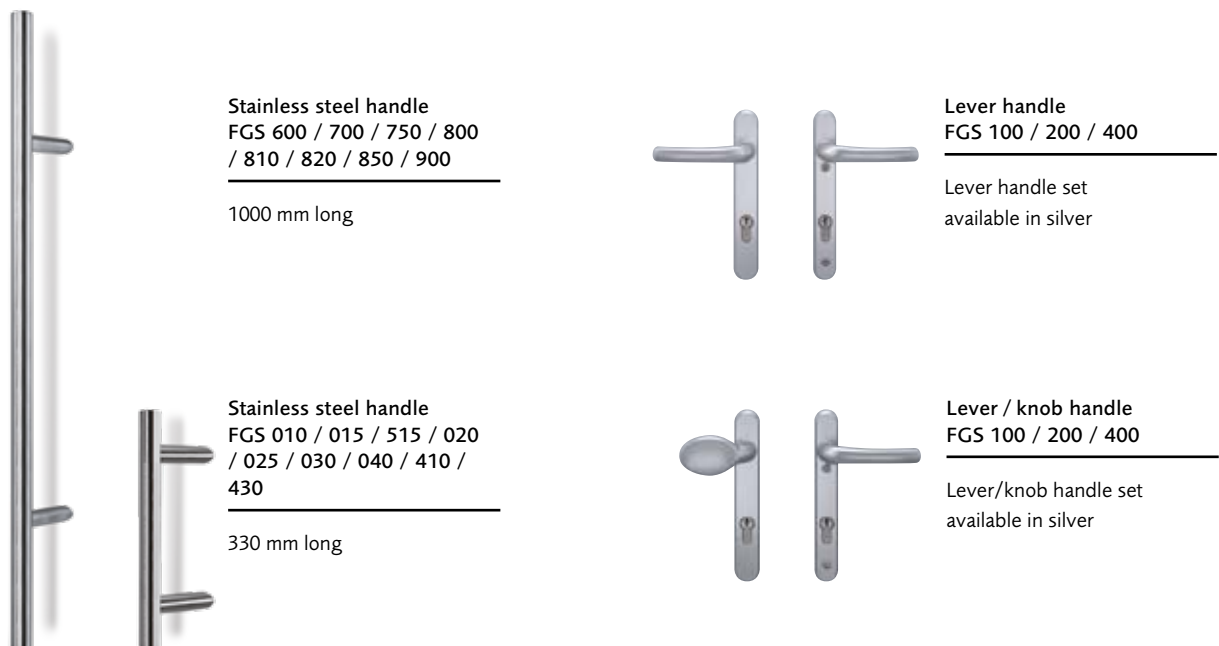
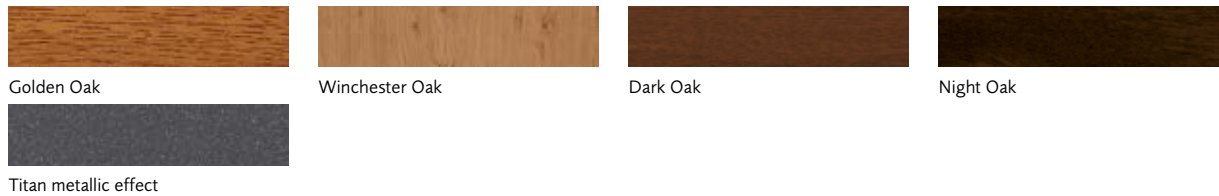

Printed colour samples are as accurate as printing techniques allow.

Glazing options and side-elements



Sand blasted Float glass



Clear Float glass

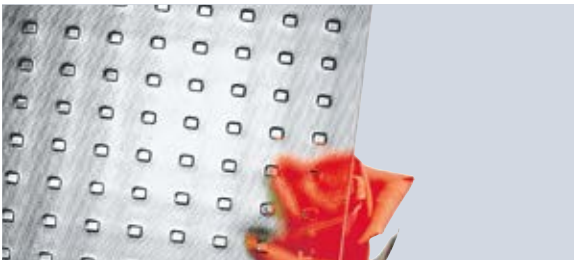

Mastercarré design standard on Contemporary doors except FGS 040



Ornamental glass



Hammered glass

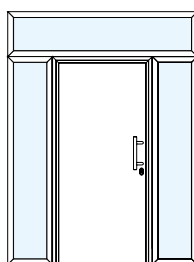
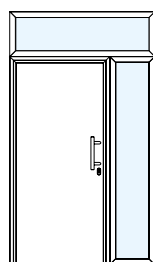
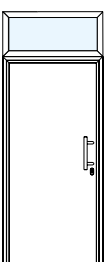
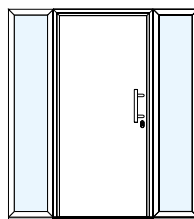
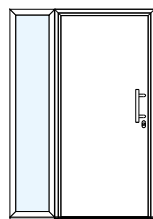
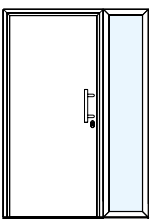

Explore the Garador range online

Our garage doors are available in a comprehensive range of sizes, colours and options. You can view our full collection of garage doors, front doors and accessories online by visiting www.garador.co.uk





GARADOR

The Garage Door People

Bunford Lane, Yeovil, Somerset, BA20 2EJ
Tel: (01935) 443722 Fax: (01935) 443744

www.garador.co.uk



Garador is the UK's leading manufacturer of garage doors and operators, with an ultra-modern production facility located in Somerset. We use German engineering expertise to produce highly sophisticated doors and operators. By purchasing a Garador product you can be assured of the highest level of quality, safety and security. With a nationwide network of stockists, installers and service technicians we are an ideal partner for your project.